

Epson Professional Imaging | Built to Perform.



Official Sponsor

EPSON®



The Rumors Are True.

For over three years, Epson dedicated a team of mechanical, chemical, and software engineers to create an all-new imaging technology dedicated for printing directly to garments. This endeavor allowed us to rethink everything and ultimately design a garment printer that was meant to be.

Introducing the Epson SureColor® F2000 Series



Epson SureColor F2000 Series

Better Performance. More Profit.

www.proimaging.epson.com

EPSON®

To Improve the **Print Quality** of
Direct-to-Garment Digital Printing.

To Improve the **Reliability** of
Direct-to-Garment Digital Printing.

■ Direct-to-Garment Printing of T-Shirts Has Many Advantages

- When printing less than 200 shirts per day
- When printing any number of shirts that vary
- When printing a four-color process design (photographic) shirt
- When the design requires more than 5 color layers or “screens”
- When printing short-runs or single-shirt orders
- When an extremely photographic or complex hi-resolution shirt design is required

■ Traditional Screen Printing of T-Shirts is Important

- When printing over 200 shirts of the same design
- When a brand or spot color needs to be exact
- When using custom or specialty inks such as glow-in-the-dark or metallics, etc.
- When the absolute lowest cost-per-shirt is required



Ideal for DTG



Ideal for Screen Print

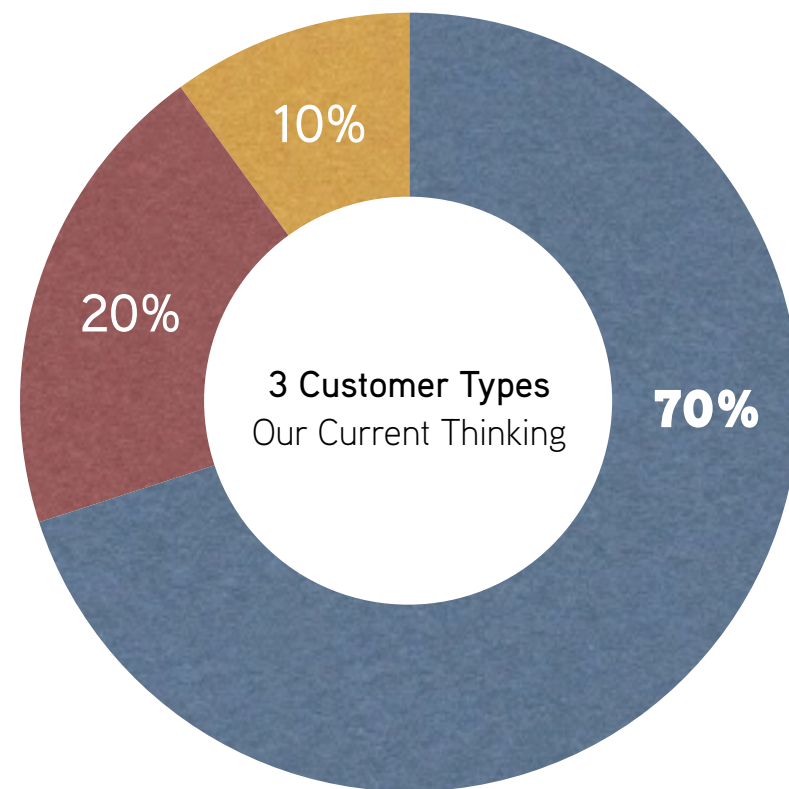

■ **High Volume – Over 1,000 Shirts per Month – 70%**

- Traditional screen printers requiring a high performance on-demand solution
- Print-on-demand eCommerce business models that are 100% DTG
- Key thoughts are reliability, productivity, and cost-per-garment

■ **Mid Volume – Up to 1,000 Shirts per Month – 20%**

- Traditional screen printer requiring DTG to add new value products for their customers
- Key thoughts are financial payback from acquiring DTG technology and ease-of-use

■ **Low Volume – Up to 500 Shirts per Month – 10%**

- Small home-based or side-based eCommerce business
- DTG is 100% of their printing business
- Key thoughts are return-on-investment, ease-of-use, small footprint, and standard power



The Epson SureColor F2000 Series

SureColor F2000 White Edition
SureColor F2000 Color Edition



SureColor F2000
White Edition

4-Color + White



SureColor F2000
Color Edition

Dual 4-Color



PrecisionCore™ TFP Print Head
New commercial-grade print head technology
designed specifically for DTG imaging

Simple Front Control Panel
Full Color LCD with Image Preview

Robust Garment Bed
Medium-size 14" x 16" Included

Optional Garment Bed Sizes
Small 10" x 12"
Large 16" x 20"
Sleeve 4" x 4"



Easy Top Access Cover
Used for Printer Maintenance and
Viewing of Garments Being Printed

USB Memory Port
Perfect for PC-Free Printing Workflows

Ethernet & USB
Compatible with Macintosh® & Windows®

Ink Cartridge Locations
600 ml or 250 ml Sizes Available
6 Ink Cartridges in Total

Clean Simple Design
All New Printer Developed by Epson

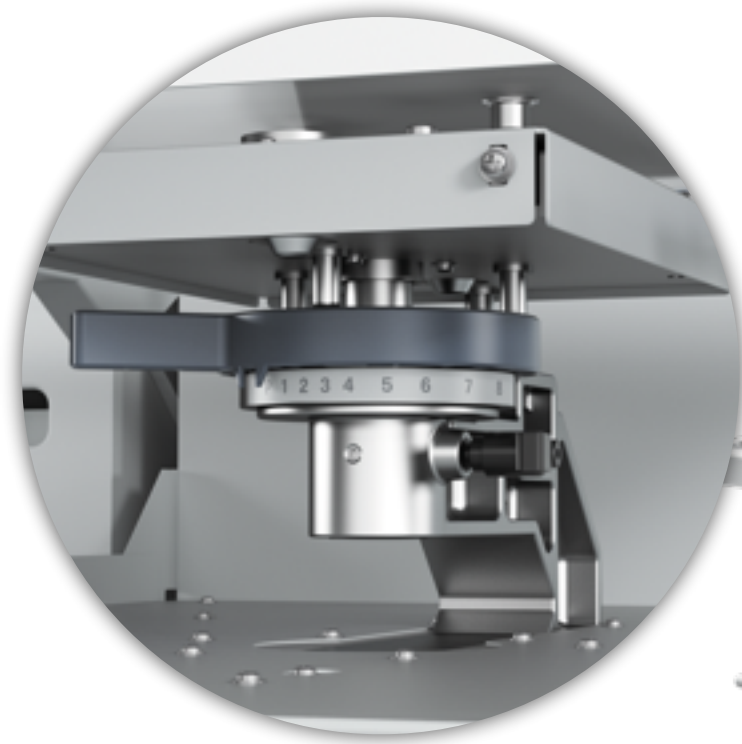

User-Adjustable Platen Height Setting

Printer then automatically verifies the surface height of the garment before printing.

This system allows for faster load times and more reliable everyday production.



Please Note:

Proper use of the Platen Height is required to reduce internal ink misting.

Second-Level Ink Filtering System

Further increasing print head life, an internal ink filtering system cleans the inks of contaminants a second time before entering the print head.

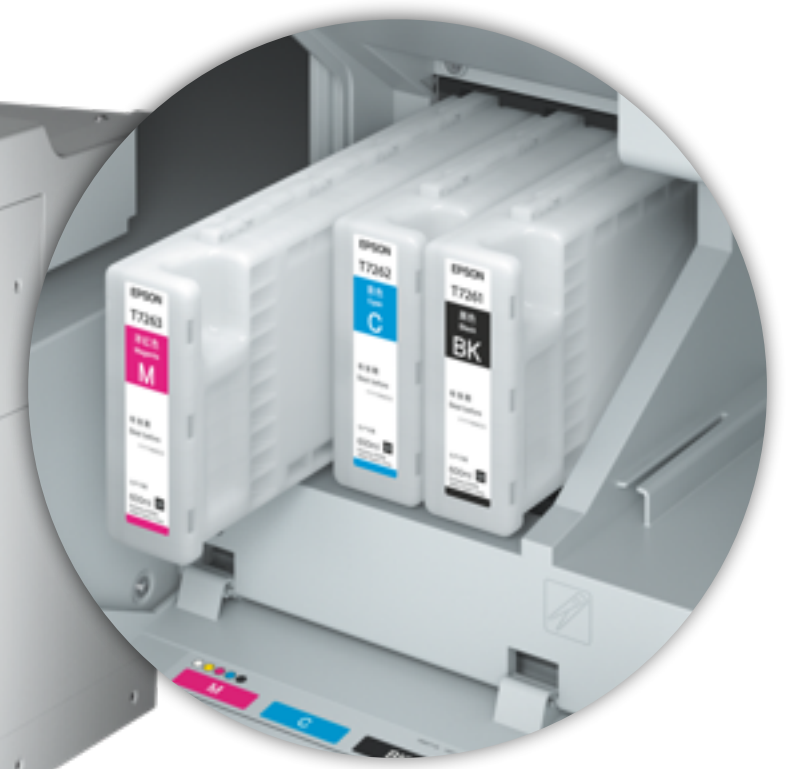

**New Smart Filtering
Ink Cartridge Technology**

Each cartridge has a built-in ink filter to better ensure ink entering the system is clear of contaminants.

Robust Ink Filtering Technology

Improves Print Head Life and Reliability

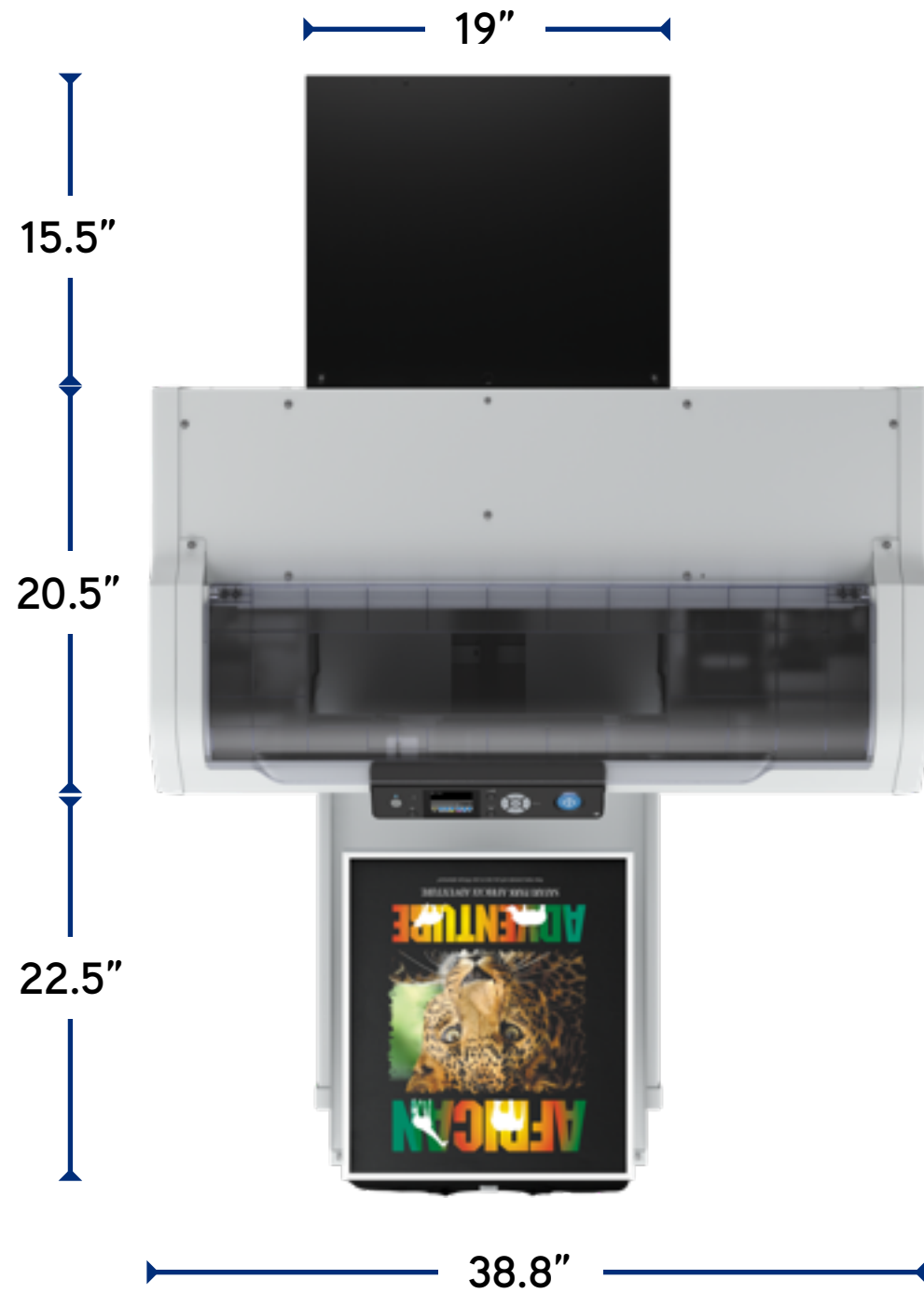

Total Weight 183 lb.



Epson PrecisionCore™

Next-Generation Print Head Technology



EPSON®

■ All-New High-Density Print Chip Core

- Advanced Thin Film Piezo (TFP) print chip core is only 1/1,000 mm thin
- Precision dot control for extreme print clarity and sharpness
- By utilizing more advanced piezo materials, a higher-level of print head durability is achieved

■ High-Precision MEMS Manufacturing Process

- Based on the Micro-Electro-Mechanical Systems process for an unparalleled level of manufacturing efficiency for consistent production quality

■ Outstanding Ink Flexibility

- The PrecisionCore print chip is capable of printing with a wide-range of ink types

■ Scalable Print Performance

- The PrecisionCore chip, delivers commercial-grade performance in a compact, modular form, and enables Epson to scale the technology, from single-pass industrial presses, to professional and consumer printers.



PRECISIONCORE

360
nozzles
per inch

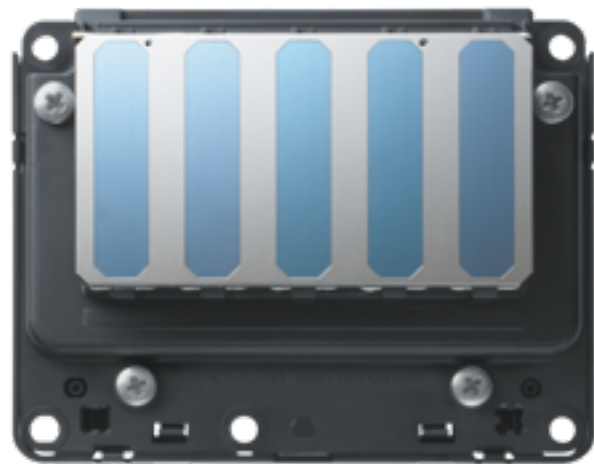

Epson PrecisionCore TFP
Actual Print Head used in the
SureColor F2000 Series

■ Extreme Print Quality

- Print resolutions up to 1,440 x 720 dpi for color; and up to 1,440 x 1,440 for white
- Precision dot control for outstanding clarity and sharpness for garment imaging

■ Fast Print Speeds

- Up to 720 nozzles per inch dedicated to color inks; with 1,440 nozzles per inch dedicated to white inks for incredible print speeds
- Quite possibly one of the fastest direct-to-garment printers in it's class

■ Commercial-Grade Reliability

- The PrecisionCore print chip is ideal for printing with direct-to-garment ink chemistry
- Co-developed with Epson UltraChrome DG ink technology for extreme reliability
- Capable of very high-production, with very little downtime for maintenance

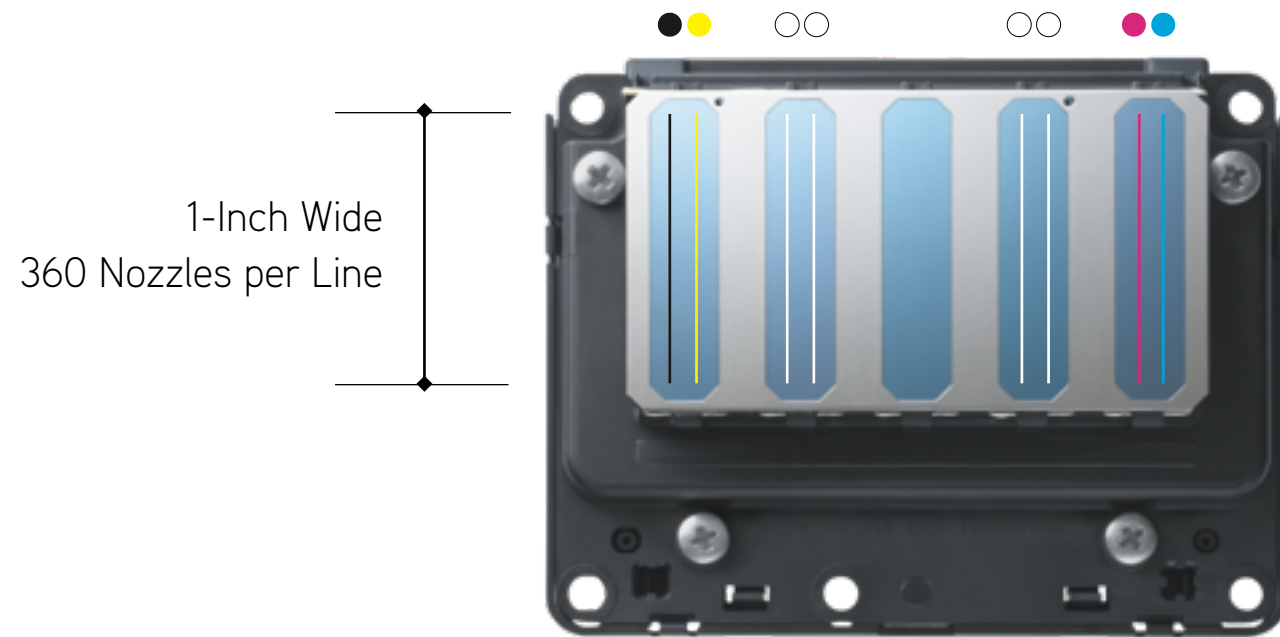

SureColor F2000
White Edition

360 Nozzles per Color
1,440 Nozzles for White

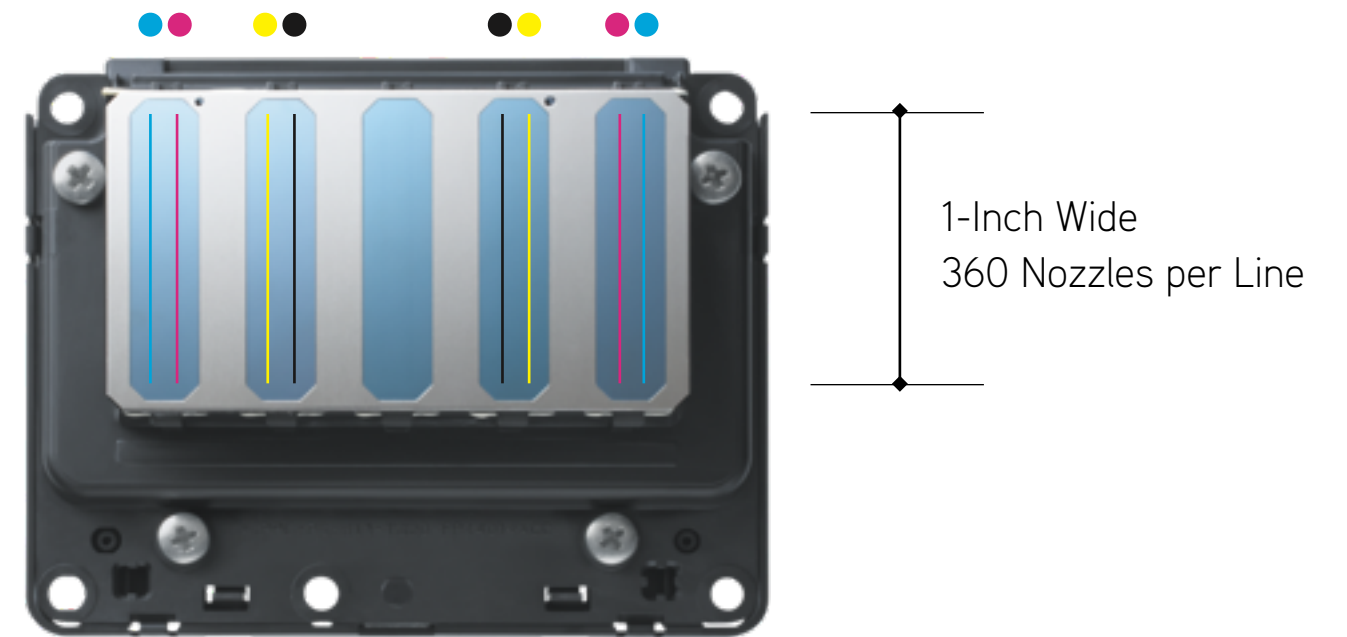

SureColor F2000
Color Edition

720 Nozzles per Color



Performance Benchmarking

Epson SureColor F2000 Series



PRECISION**CORE**

EPSON®

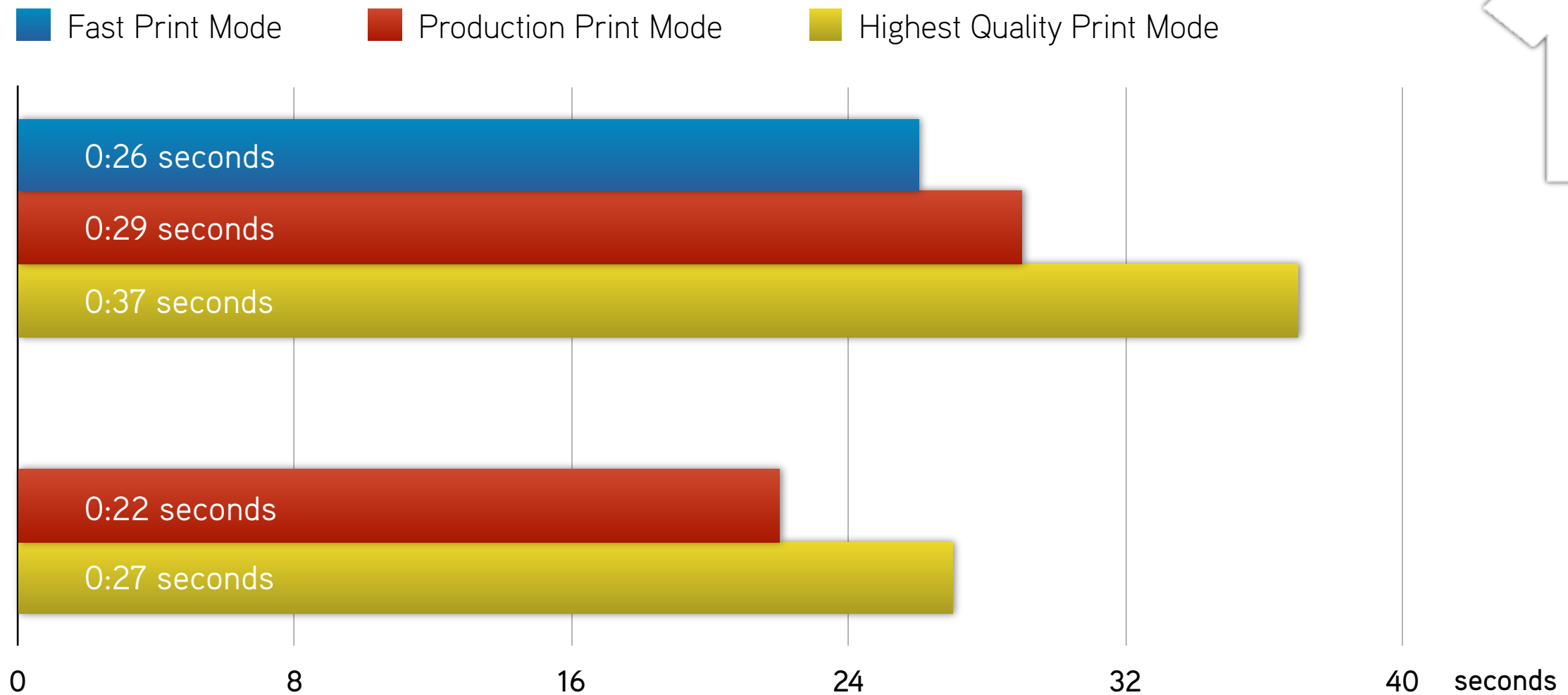
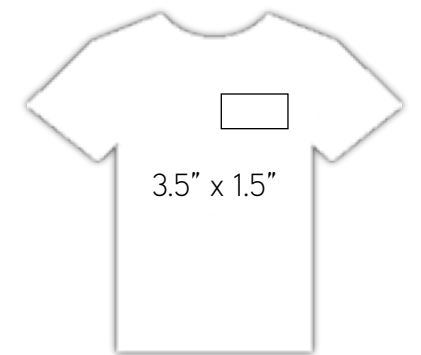

Print times shown are based upon a loaded garment entering the printer, actual printing of the garment, then exiting of the garment for removal. Computer processing, network transmission, and loading & unloading of garments are not included in these times. Actual print times will vary. Testing conducted by Epson America, Inc. as of September 2013.

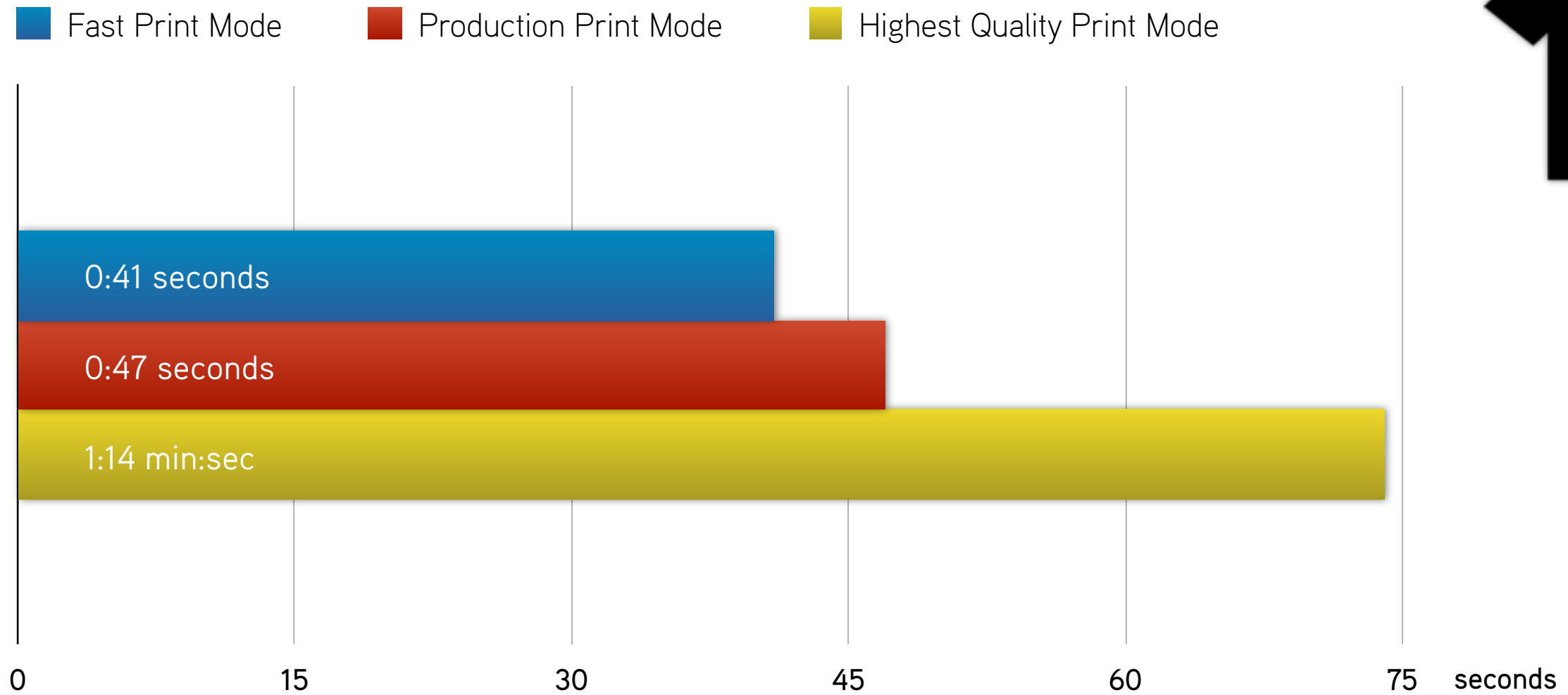
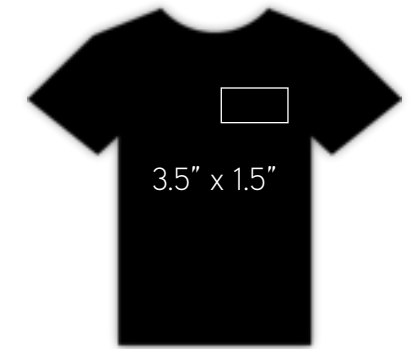

SureColor F2000
White Edition

Print times shown are based upon a loaded garment entering the printer, actual printing of the garment, then exiting of the garment for removal. Computer processing, network transmission, and loading & unloading of garments are not included in these times. Actual print times will vary. Testing conducted by Epson America, Inc. as of September 2013.

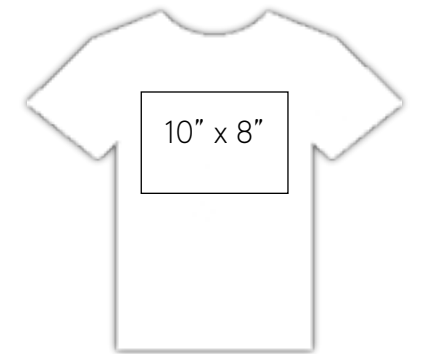

■ Fast Print Mode ■ Production Print Mode ■ Highest Quality Print Mode

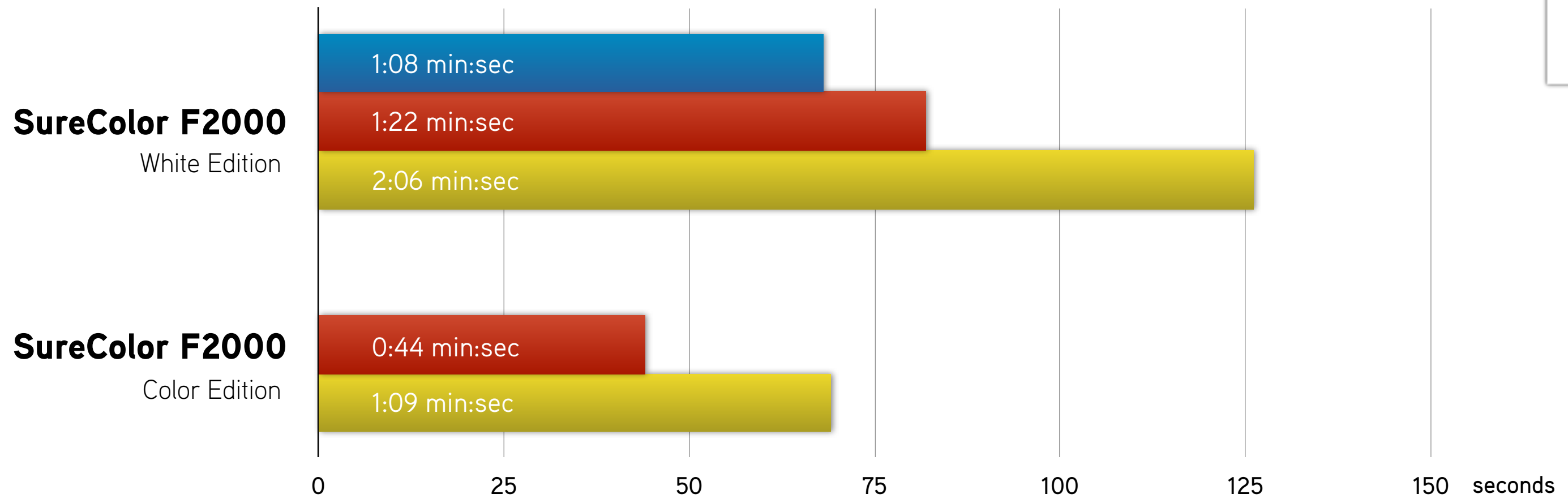

Print times shown are based upon a loaded garment entering the printer, actual printing of the garment, then exiting of the garment for removal. Computer processing, network transmission, and loading & unloading of garments are not included in these times. Actual print times will vary. Testing conducted by Epson America, Inc. as of September 2013.

10" x 8" Upper Chest - Color with White Print

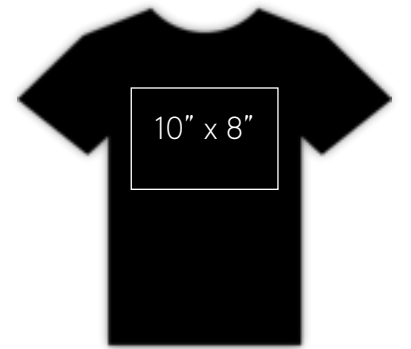

■ Fast Print Mode ■ Production Print Mode ■ Highest Quality Print Mode

SureColor F2000
White Edition

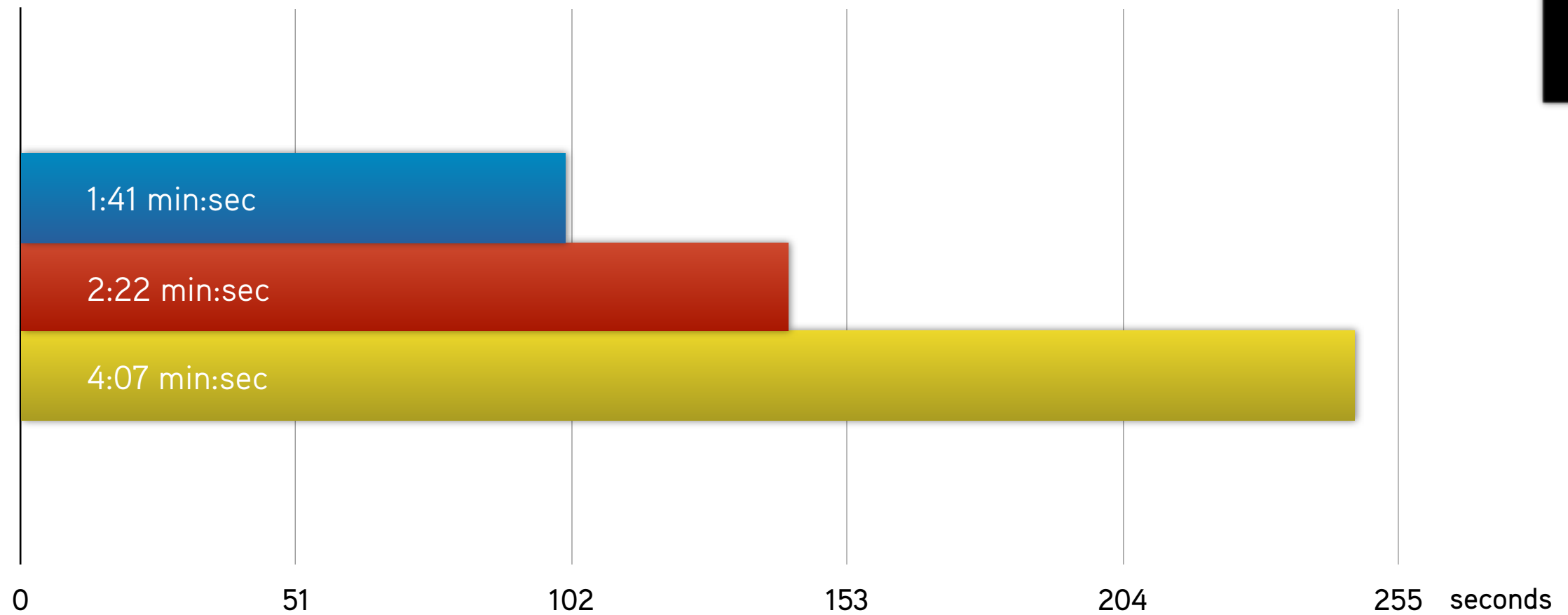

Print times shown are based upon a loaded garment entering the printer, actual printing of the garment, then exiting of the garment for removal. Computer processing, network transmission, and loading & unloading of garments are not included in these times. Actual print times will vary. Testing conducted by Epson America, Inc. as of September 2013.

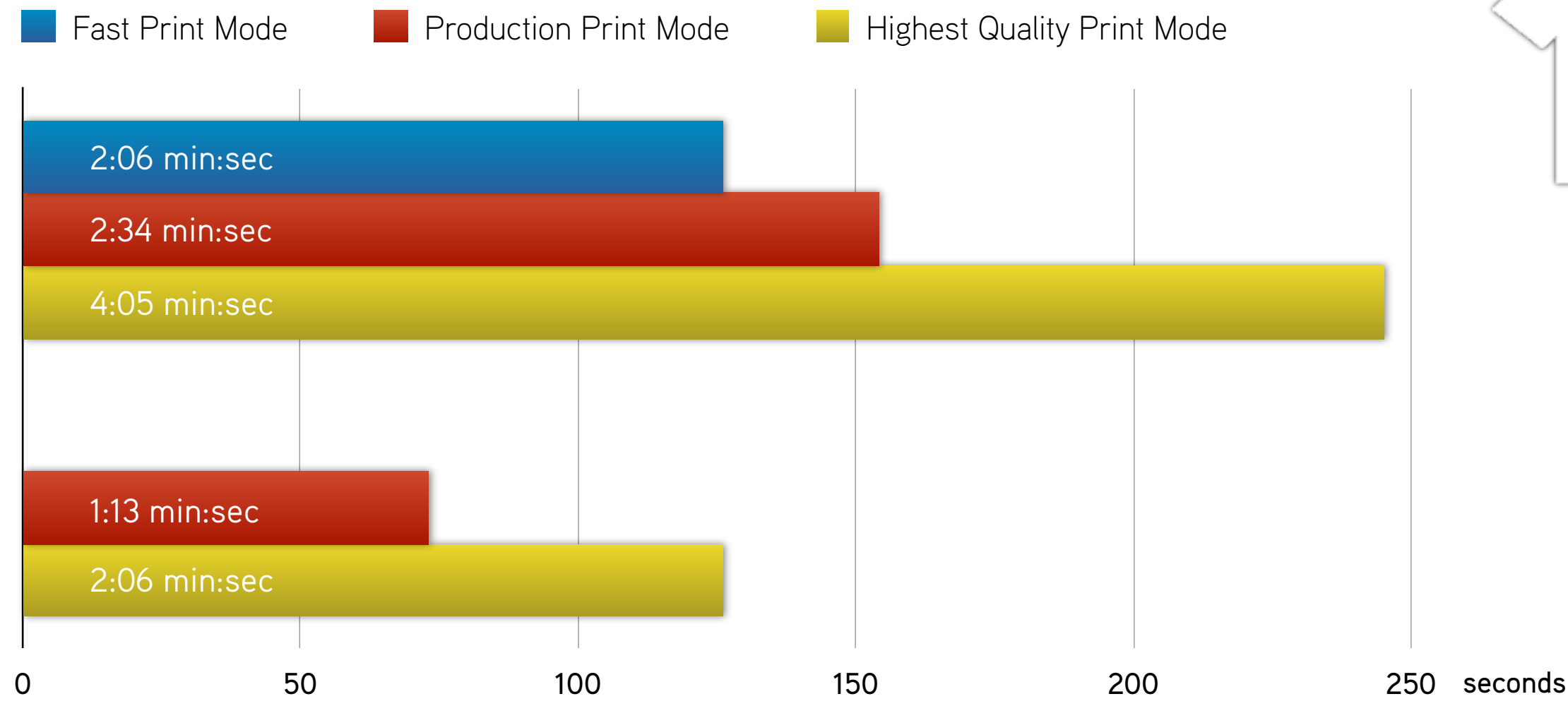
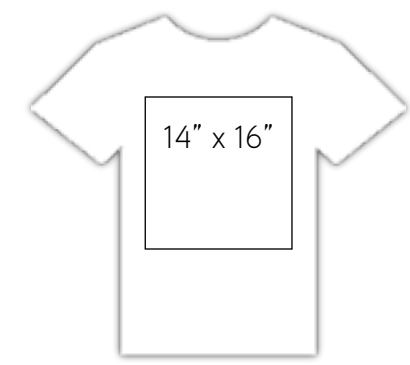

Print times shown are based upon a loaded garment entering the printer, actual printing of the garment, then exiting of the garment for removal. Computer processing, network transmission, and loading & unloading of garments are not included in these times. Actual print times will vary. Testing conducted by Epson America, Inc. as of September 2013.

14" x 16" Center Chest - Color with White Print

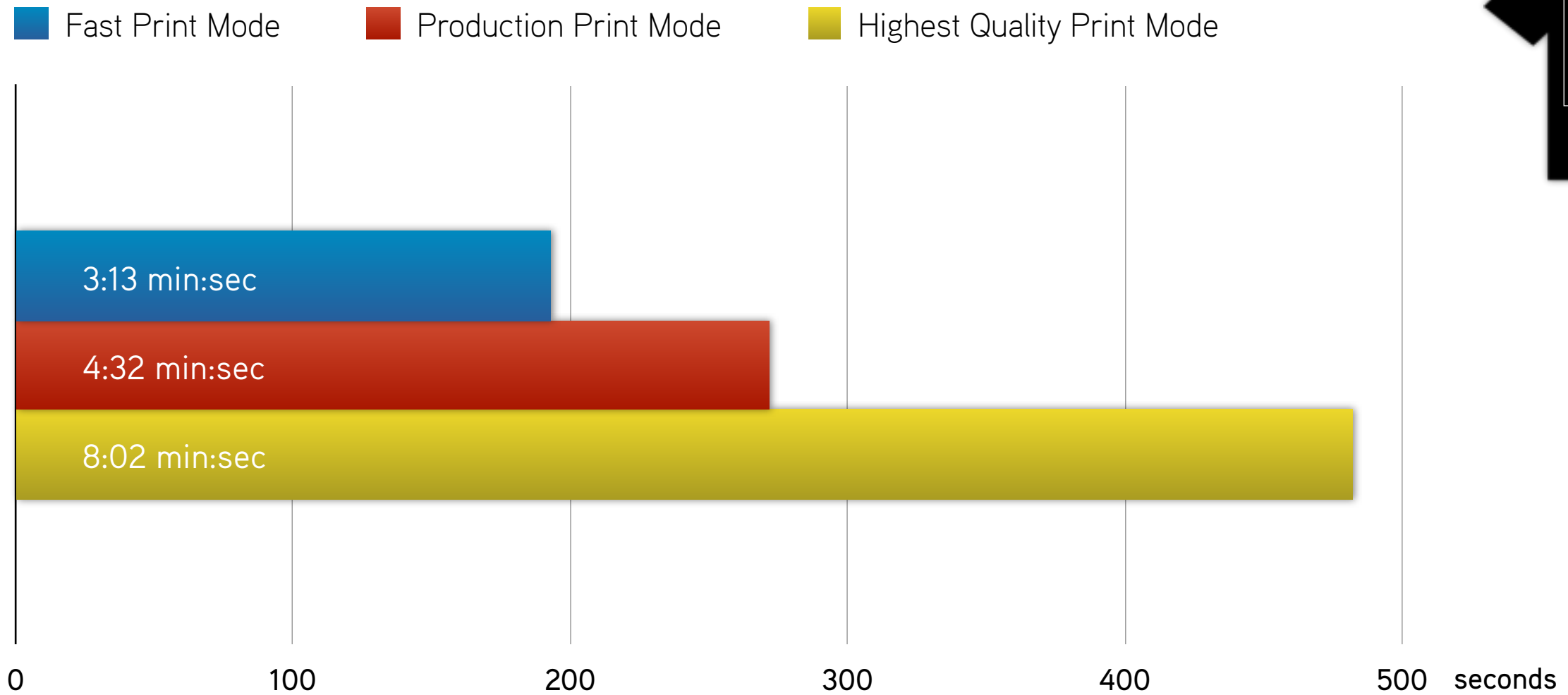
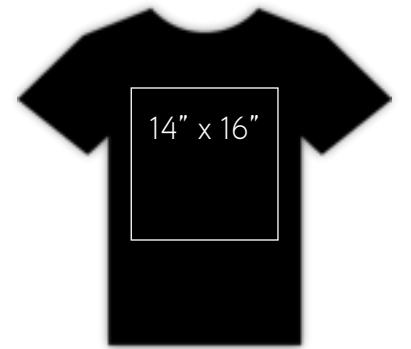

SureColor F2000
White Edition

Print times shown are based upon a loaded garment entering the printer, actual printing of the garment, then exiting of the garment for removal. Computer processing, network transmission, and loading & unloading of garments are not included in these times. Actual print times will vary. Testing conducted by Epson America, Inc. as of September 2013.

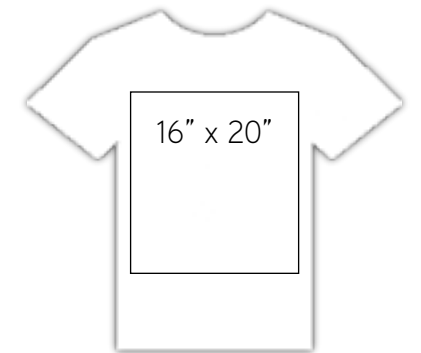

■ Fast Print Mode ■ Production Print Mode ■ Highest Quality Print Mode

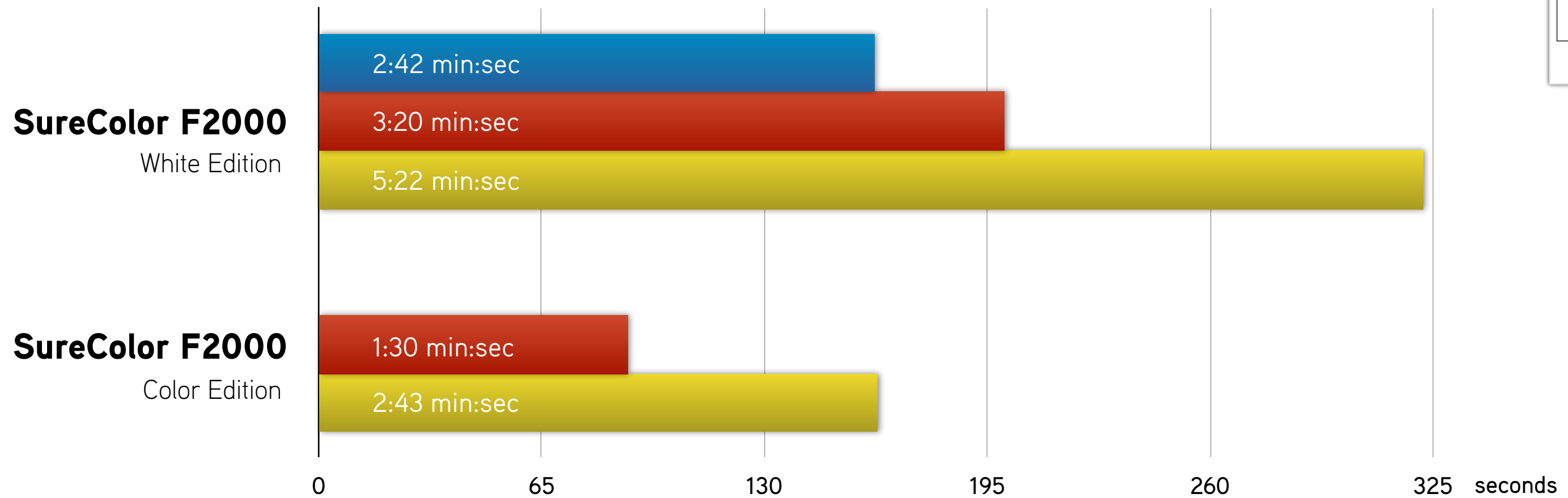

Print times shown are based upon a loaded garment entering the printer, actual printing of the garment, then exiting of the garment for removal. Computer processing, network transmission, and loading & unloading of garments are not included in these times. Actual print times will vary. Testing conducted by Epson America, Inc. as of September 2013.

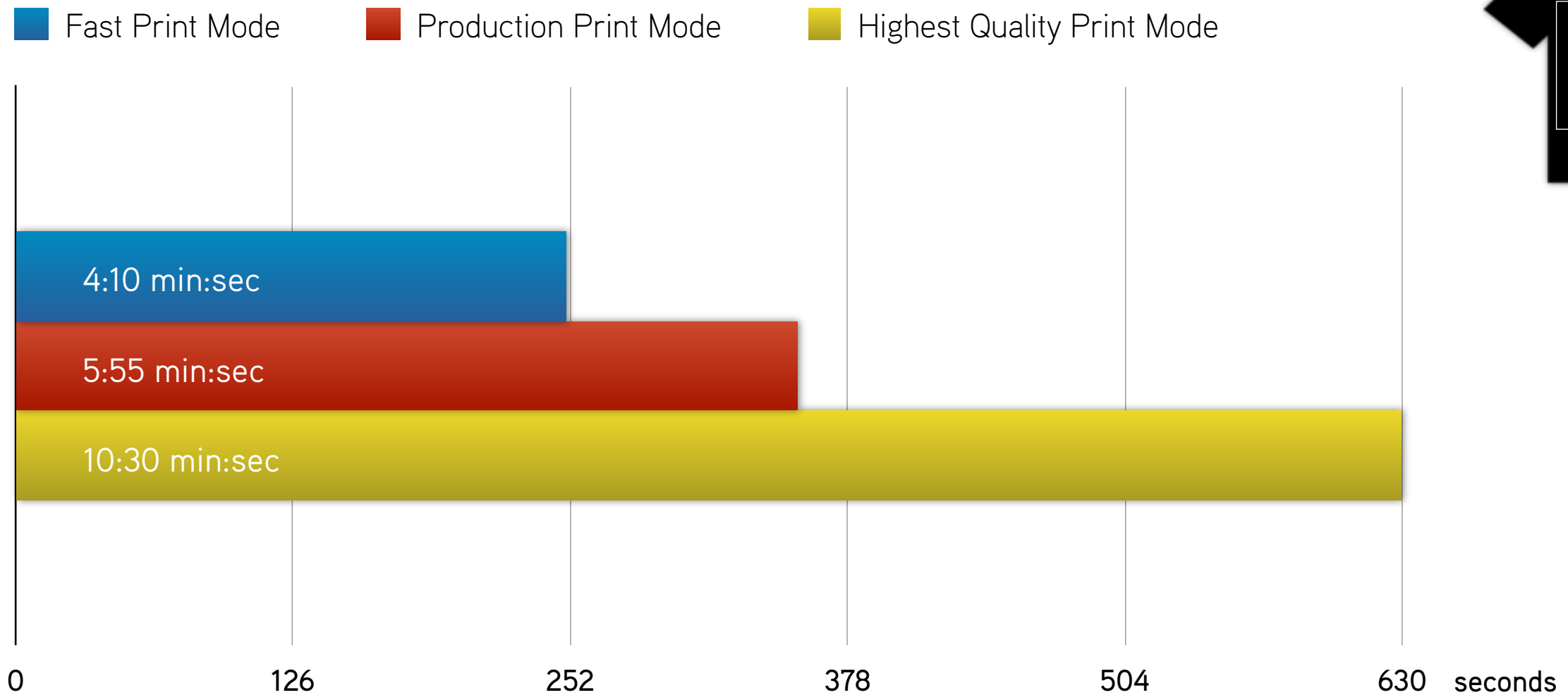
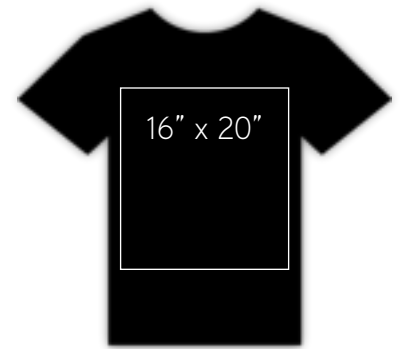

SureColor F2000
White Edition

Print times shown are based upon a loaded garment entering the printer, actual printing of the garment, then exiting of the garment for removal. Computer processing, network transmission, and loading & unloading of garments are not included in these times. Actual print times will vary. Testing conducted by Epson America, Inc. as of September 2013.



Epson UltraChrome[®] DG Ink

A High-Performance Garment Ink Technology Developed by Epson

all new ink
technology from
Epson



■ Internally Developed by Epson

- New pigment ink technology designed for cellulose-based garment imaging
- Compatible with both 100% cotton or cotton blends
- Developed together with the print head technology to improve overall reliability

■ Outstanding Color Performance

- Clean, bright, accurate color for outstanding finished garments

■ Next-Generation White Ink Technology

- New high-dispersion ink technology helps to reduce white ink sedimentation
- Very high white ink density, with a very natural white color

■ Robust Garment Durability

- Overall garment durability is being independently tested based upon the industry standard AATCC testing method
- Visit www.proimaging.epson.com for final results



Epson Garment Creator

Garment Printing Workflow Software from Epson

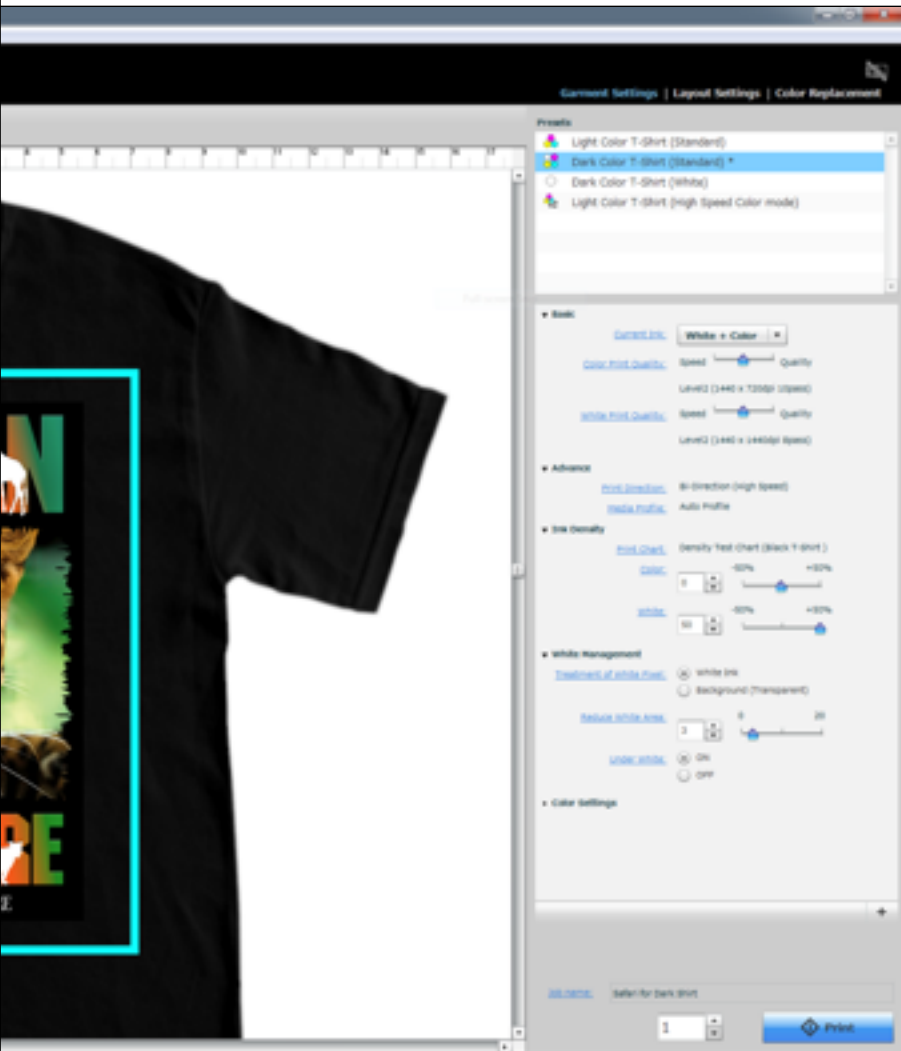

■ Free Workflow Software Developed by Epson

- Raster-based software application supporting - JPEG, TIFF, PNG, and BMP graphic files
- Available for both Apple® Macintosh® and Microsoft® Windows® platforms
- Available via free internet download only

■ Easy-to-Use Garment Layout

- Choose your platen size, place your image file, position, scale, rotate, etc. - then print
- Very simple interface - quick learning-curve

■ Robust Color and White Ink Control

- Independent controls for color and white imaging - even on the same garment
- Powerful color adjustment features

■ Built-In Job Accounting Tools

- Keeps track of ink usage by job for better cost estimation and expense tracking



Epson Pretreatment Fluid

All-New White Ink Pretreatment Developed by Epson





■ Developed by Epson Specifically for Epson UltraChrome DG Inks

- A great solution for treating garments intended for white ink imaging
- Provides for an ideal base for outstanding white ink density

■ Extremely Soft Hand

- Unlike other pretreatment fluids - the finished garment feels very soft
- No sticky residue or odor

■ Reduced Garment Staining

- Very little visible outline or stain compared to other forms of pretreatment fluid
- Washes out in the first wash
- Developed to help repel lint from the clothes dryer

■ Competitively Priced

- Available in 20 liter boxes and creates 40 liters of fluid by mixing 1:1 with distilled water



Printer Maintenance

Epson SureColor F2000 Series

■ General Printer Maintenance Routine

- Print the internal print head **Nozzle Check** pattern to verify nozzle health - once per day
- If required, perform an automatic **Print Head Cleaning** cycle - ink is use
- When instructed by the printer, replace the **Print Head Capping Station, Print Head Fabric Wiper, and Print Head Flushing Pad** - replaced after approximately 1,000 shirts
- As required, clean the **Print Head Cleaning Cap** - about once per week

■ White Ink Maintenance Routine

- When instructed, remove the white ink cartridges and **Shake** them - once per day
- When instructed, perform a **White Ink Flushing** - about once per month - ink is used
- The printer will perform a daily automatic **White Ink Circulation** - no ink used

■ Color Ink Maintenance Routine

- When instructed, remove the color ink cartridges and **Shake** them - about once per month



Printer Maintenance

Designed for Simple User Maintenance

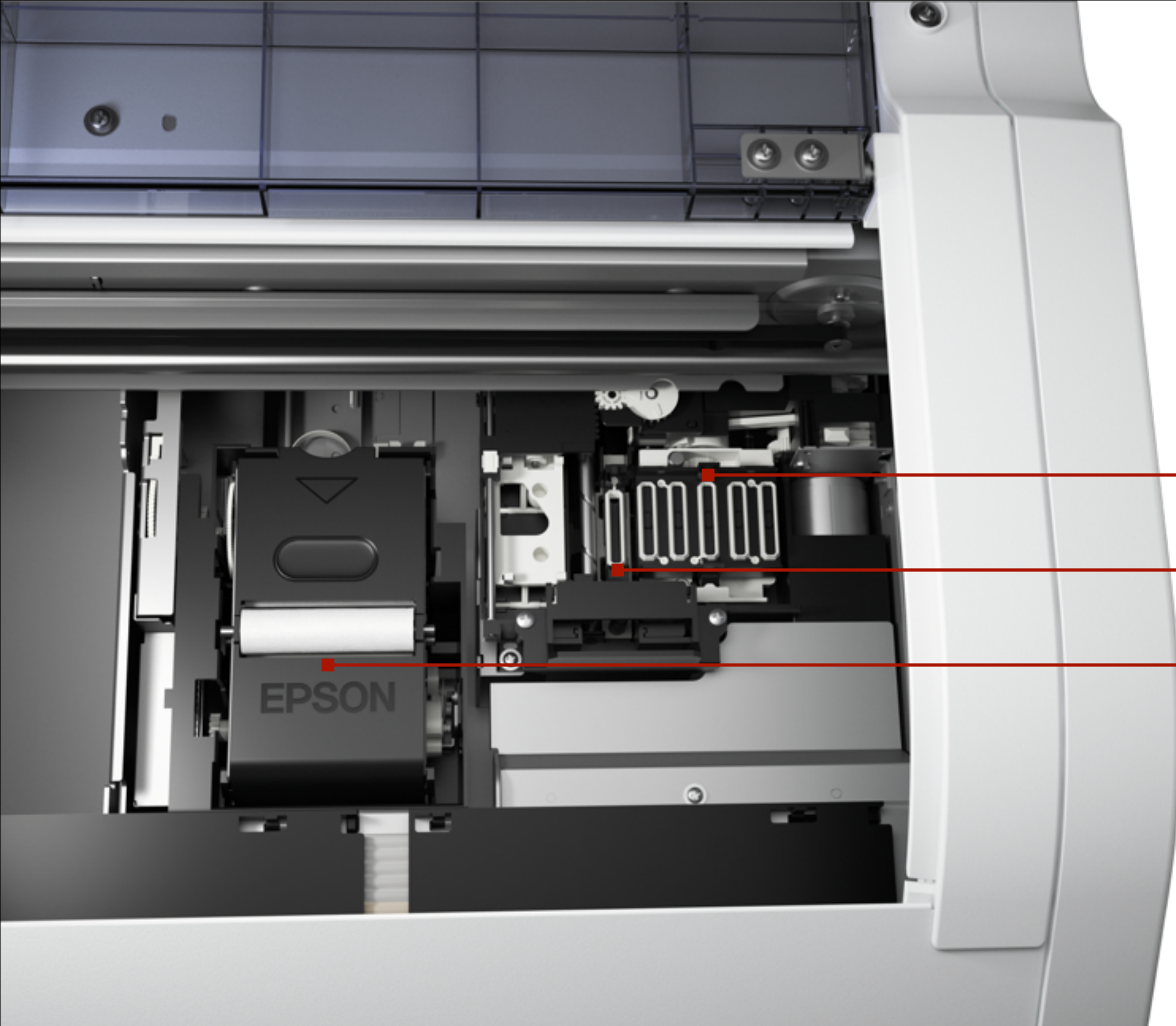

Print Head Capping Station
User Replaceable

Print Head Cleaning Cap
Clean as Needed

Print Head Fabric Wiper
User Replaceable

Printer Maintenance

Designed for Simple User Maintenance

Print Head Flushing Pad
User Replaceable

Printer Air Filter
User Replaceable

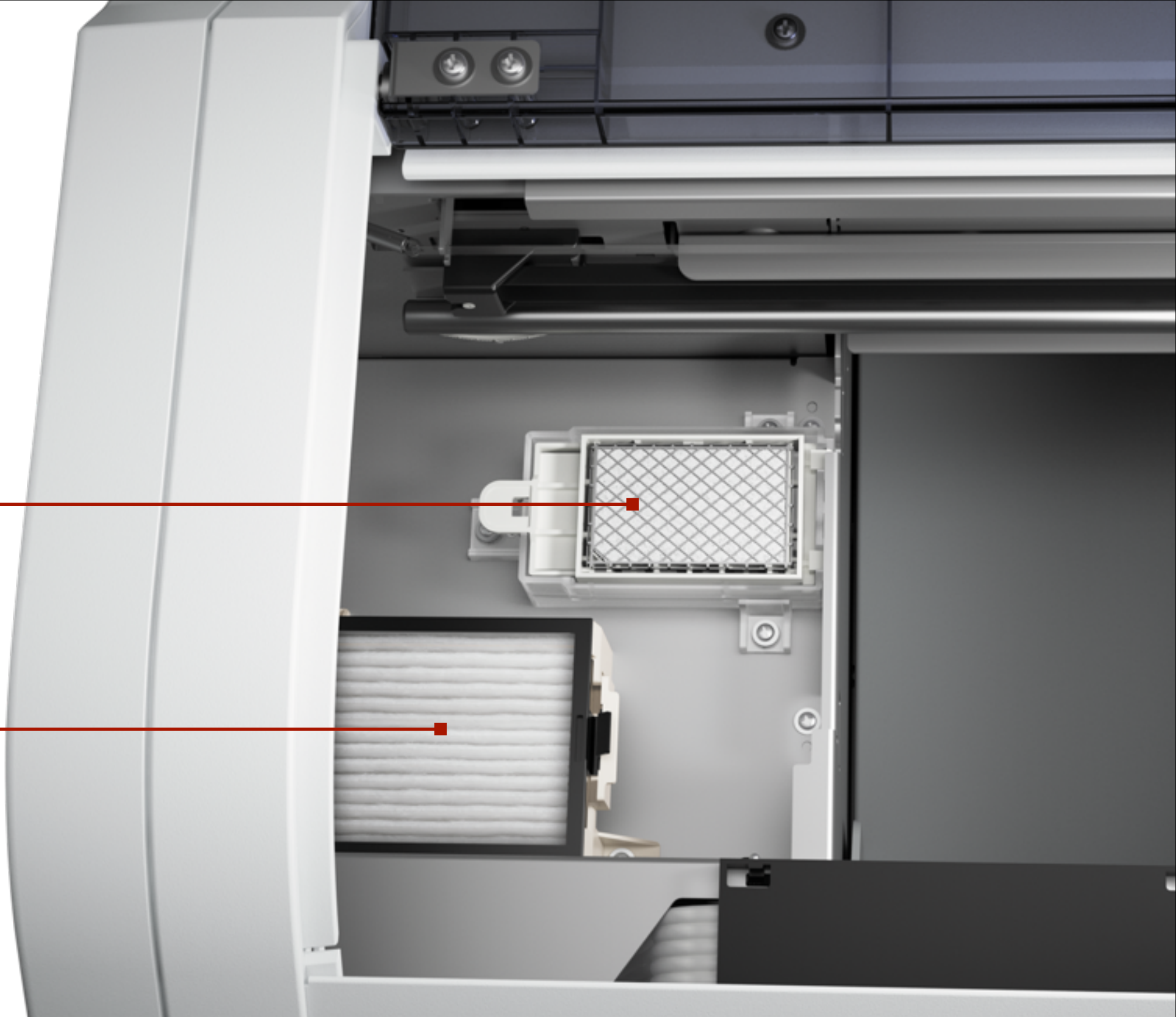



Warranty & Support Programs

Epson Preferredsm Service

■ Standard 1-Year Epson Preferred Service

- Free technical phone support Monday thru Friday from 6:00am until 6:00pm PST
- If required, free usually next business day onsite break-fix service
- Includes all parts and labor – including print heads
- Covers the printer, genuine Epson optional accessories, and Epson software

■ Optional 1-Year Epson Preferred Plus Service Extension

- Extends the standard 1-year Epson Preferred Service program by an additional 1-Year
- Can be purchased at anytime while still under an Epson Preferred Service program
- Can be “stacked” twice for up to 3-years of total coverage (1 yr warranty + 2 plans)

■ Sold Exclusively Through Experienced DTG Resellers

- Epson is dedicated in finding and supporting only the best DTG resellers
- Provides for an additional-level of local customer service - above and beyond Epson

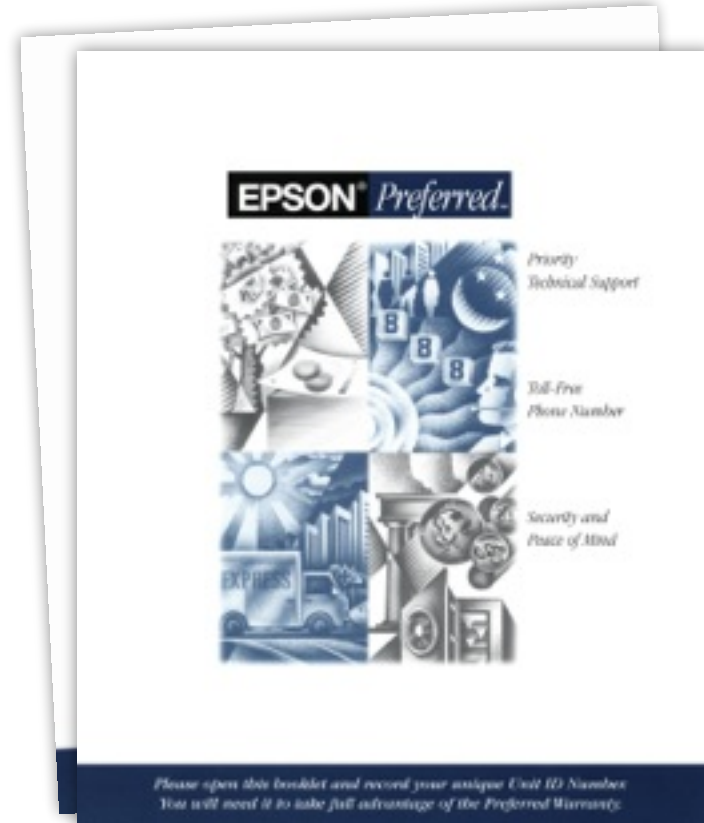



Product Comparison & Selling Proposition

Epson SureColor F2000 Series

	SureColor F2000 White Edition	SureColor F2000 Color Edition
Maximum Print Size	16" x 20"	16" x 20"
Color Configuration	CMYK + White	CMYK
Print Head Technology	Epson PrecisionCore	Epson PrecisionCore
Print Head Chip Design	TFP (one-inch wide)	TFP (one-inch wide)
Nozzles Dedicated to Color	360 nozzles per color	720 nozzles per color
Nozzles Dedicated to White	1,440 nozzles	No Applicable
Maximum Print Resolution - Color Pass	1,440 x 720 dpi (16-Pass)	1,440 x 720 dpi (8-Pass)
Maximum Print Resolution - White Pass	1,440 x 1,440 dpi (8-Pass)	Not Applicable
Ink Technology	Epson UltraChrome DG	Epson UltraChrome DG
Ink Cartridge Sizes	250 ml or 600 ml	250 ml or 600 ml
Ink Cartridge Configuration	6 Cartridges (C M Y K W W)	6 Cartridges (C C M M Y K)
Maximum On-Board Ink Capacity - Color / White	2,400 ml / 1,200 ml	3,600 ml
White Ink Pre-treatment Required?	Yes	Not Applicable
Print Speed - 10" x 8" Upper Chest - Production Mode - No White	1:22 min:sec	0:44 min:sec
Print Speed - 10" x 8" Upper Chest - Production Mode - with White	2:22 min:sec	Not Applicable
Standard Connectivity	USB 2.0 & 10/100 Base-T Ethernet	USB 2.0 & 10/100 Base-T Ethernet
Standard Warranty - Printer & Print Head	1-Year On-Site Parts & Labor	1-Year On-Site Parts & Labor

■ **Superior Garment Print Quality**

- Purpose-built print head, ink, and printer mechanism – produces outstanding print quality

■ **High-Performance Garment Production**

- One of the fastest garment printers in its price class – runs all day with little downtime

■ **Superior Printer Reliability**

- Developed specifically for high-performance, direct-to-garment imaging
- Not a converted Epson photo or consumer printer model

■ **Low Cost-of-Ownership**

- Large-capacity individual ink cartridges up to 600 ml per color for a low cost-per-ml
- Attractive printer pricing for a faster return-on-investment

■ **World Class Service & Support**

- Standard 1-year next-business-day on site service - includes print heads
- Free phone support available Monday thru Friday

amazing
print quality
&
highly
reliable



Product Pricing & Part Numbers

Epson SureColor F2000 Series

	PART NUMBER	MSRP
Epson SureColor F2000 White Edition (CMYK + White)	SCF2000WE	\$19,995.00
Epson SureColor F2000 Color Edition (CMYK)	SCF2000SE	\$19,995.00
Small Garment Platen - 10" x 12"	C12C890913	\$349.95
Medium Garment Platen - 14" x 16"	C12C890912	\$399.95
Large Garment Platen - 16" x 20"	C12C890911	\$499.95
Sleeve Platen - 4" x 4"	C12C891191	\$349.95

The **Epson SureColor F2000 White Edition SKU** includes the printer, a full set of 250 ml ink cartridges, two cleaning cartridges, one medium garment platen, power cable, and quick-start guide.

The **Epson SureColor F2000 Color Edition SKU** includes the printer, a full set of 250 ml ink cartridges, one medium garment platen, power cable, and quick-start guide.

All software and detailed documentation are available via free download. User must have access to the internet to download Apple Macintosh and Microsoft Windows driver software.

Pricing shown is MSRP. Please see your Authorized Epson DTG Reseller for actual street pricing.

	PART NUMBER	MSRP
Black Ink Cartridge - 250 ml	T730100	\$119.95
Cyan Ink Cartridge - 250 ml	T730200	\$119.95
Magenta Ink Cartridge - 250 ml	T730300	\$119.95
Yellow Ink Cartridge - 250 ml	T730400	\$119.95
White Ink Cartridge - 250 ml	T730A00	\$119.95
Black Ink Cartridge - 600 ml	T725100	\$229.95
Cyan Ink Cartridge - 600 ml	T725200	\$229.95
Magenta Ink Cartridge - 600 ml	T725300	\$229.95
Yellow Ink Cartridge - 600 ml	T725400	\$229.95
White Ink Cartridge - 600 ml	T725A00	\$229.95

Pricing shown is MSRP. Please see your Authorized Epson DTG Reseller for actual street pricing.

	PART NUMBER	MSRP
Cleaning Cartridge - 700 ml (used mainly for white ink maintenance routines)	T736000	\$19.95
Epson Pretreatment Fluid - 20 liter (mixed 1-to-1 with distilled water – makes 40 liters of fluid)	C13T736100	\$679.95
Print Head Cleaning Kit (replacement fabric wiper, flushing pad, & cleaning cap station)	C13S092001	\$94.95
Printer Maintenance Kit (Epson cleaning fluid, swabs, & latex gloves, etc.)	C13T736200	\$39.95
Printer Air Filter (only gets replaced if original one gets too dirty)	C13S092021	\$19.95
Waste Ink Bottle (this is a replacement - one of these comes standard with each printer)	T724000	\$32.00
Additional 1-Year Epson Preferred Plus Service (warranty extension from Epson)	EPPSCF2KB1	\$1,950.00

The Epson SureColor F2000 Series should work fine with various types of pre-treatment fluid. For consistent results, use Epson pre-treatment fluid.

Pricing shown is MSRP. Please see your Authorized Epson DTG Reseller for actual street pricing.



Specifications are Subject to Change Without Notice

Epson, Epson SureColor, Epson UltraChrome and PrecisionCore TFP, are registered trademarks of Seiko Epson Corporation.

Epson Preferred is a service mark of Epson America, Inc.

All other product and brand names are trademarks and/or registered trademarks of their respective companies.

Epson disclaims any and all rights in these marks.

Ink cost estimates in this document do not necessarily reflect the actual cost of ink for a particular printed garment, which can vary considerably based on image printed, print settings, garment type, frequency of use, and temperature.

A variable amount of ink remains in the cartridge after the "Replace Cartridge" indicator comes on.

Copyright Epson America, Inc. 2014 MR 01.2014